

## CLASSIC AND EXCLUSIVE SERIES - Specification Guide

Installation Type :: Wall Mount (Classic) and Floor-to-ceiling (Exclusive) | Display Options :: P1, P2, P3, MP1, MP2, LS | Colour Options :: 13 Colours available | Capacity :: Based on configuration | Pricing :: Based on configuration

**Classic Series** (Wall-mount) and **Exclusive Series** (Floor-to-ceiling) are available in custom configured heights from min. 12" (304.8mm) to max. 120" (3048mm).

Modular components consist of regular bottle holders (1, 2 and 3 deep), magnum sized bottle holders (1 and 2 deep) as well as LED light display shelves (LS). A combination of any of standard components and colours can make up single or multiple systems.



Classic Series



Exclusive Series

### DISPLAY OPTIONS

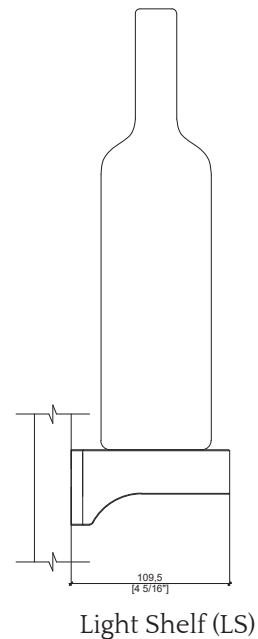
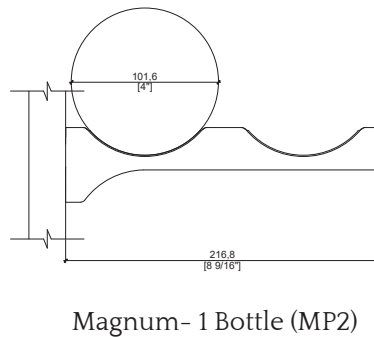
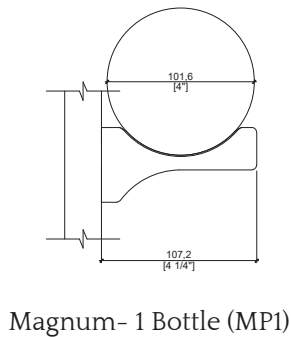
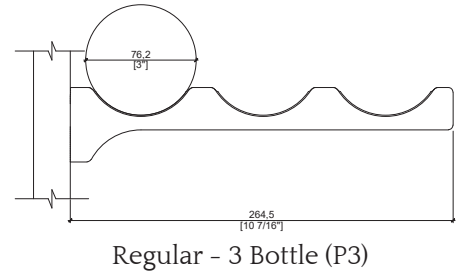
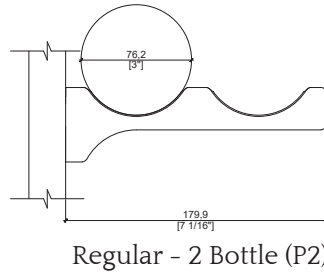
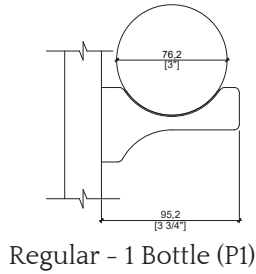

## CLASSIC SERIES - Specification Guide

### CLASSIC SERIES CONFIGURATION OPTIONS

\*options for multiple configurations may be specified in the same system

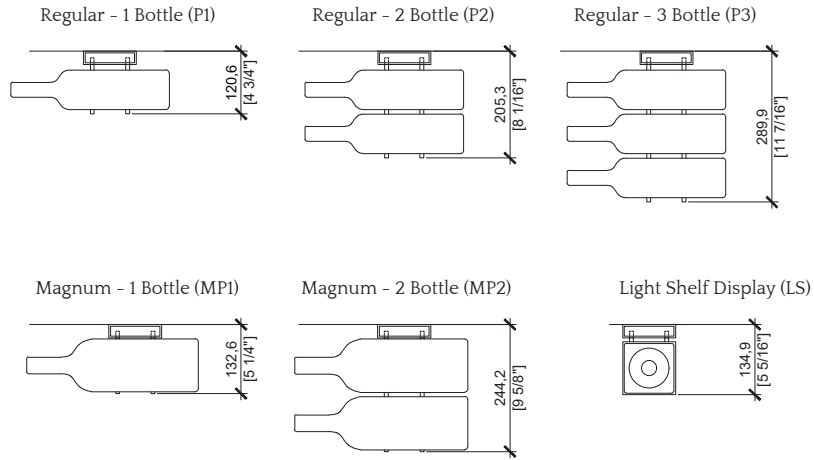

### CLASSIC SERIES SPACING REQUIREMENTS

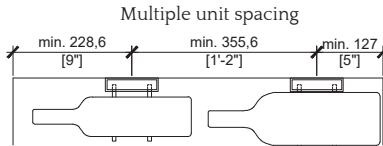

### CLASSIC SERIES POST AND FIN DETAIL

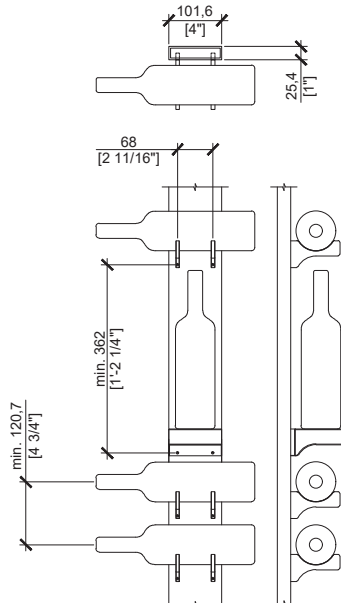

## EXCLUSIVE SERIES - Specification Guide

### EXCLUSIVE SERIES CONFIGURATION EXAMPLES

\*multiple display types may be specified in the same system

Regular - 1 Bottle (P1) - 1 SIDE

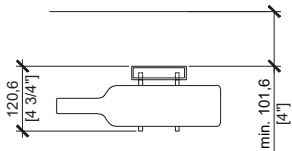

Regular - 2 Bottle (P2) - 1 SIDE

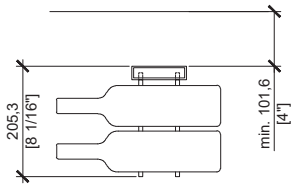

Regular - 3 Bottle (P3) - 1 SIDE

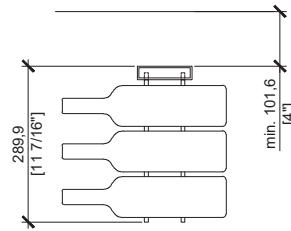

Regular - 1 Bottle (P1) - 2 SIDES

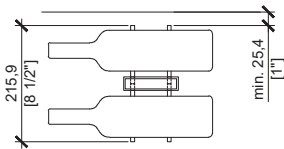

Regular - 2 Bottle (P2) - 2 SIDES

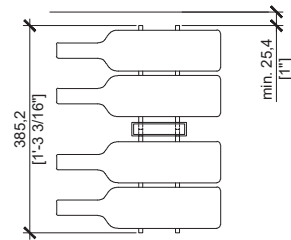

Regular - 3 Bottle (P3) - 2 SIDES

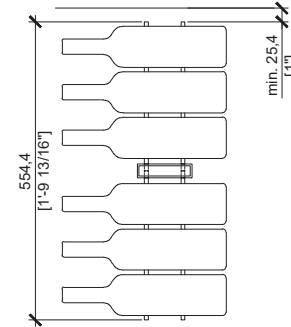

Magnum - 1 Bottle (MP1) - 1 SIDE

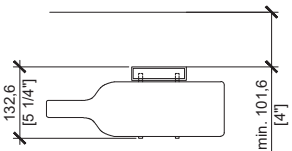

Magnum - 2 Bottle (MP2) - 1 SIDE

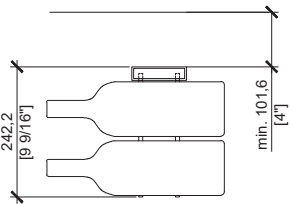

Light Shelf Display (LS) - 1 SIDE

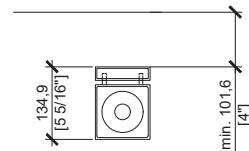

Magnum - 1 Bottle (MP1) - 2 SIDES

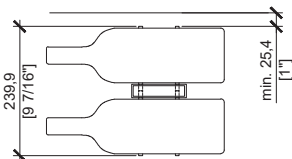

Magnum - 2 Bottle (MP2) - 2 SIDES

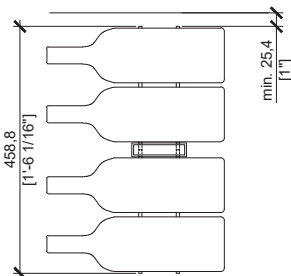

Light Shelf Display (LS) - 2 SIDES

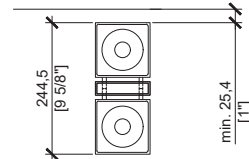

## EXCLUSIVE SERIES - Specification Guide

### EXCLUSIVE SERIES SPACING REQUIREMENTS

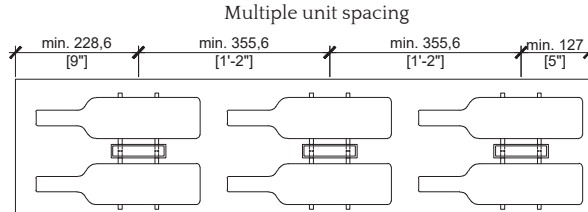

### EXCLUSIVE SERIES POST AND FIN DETAILS

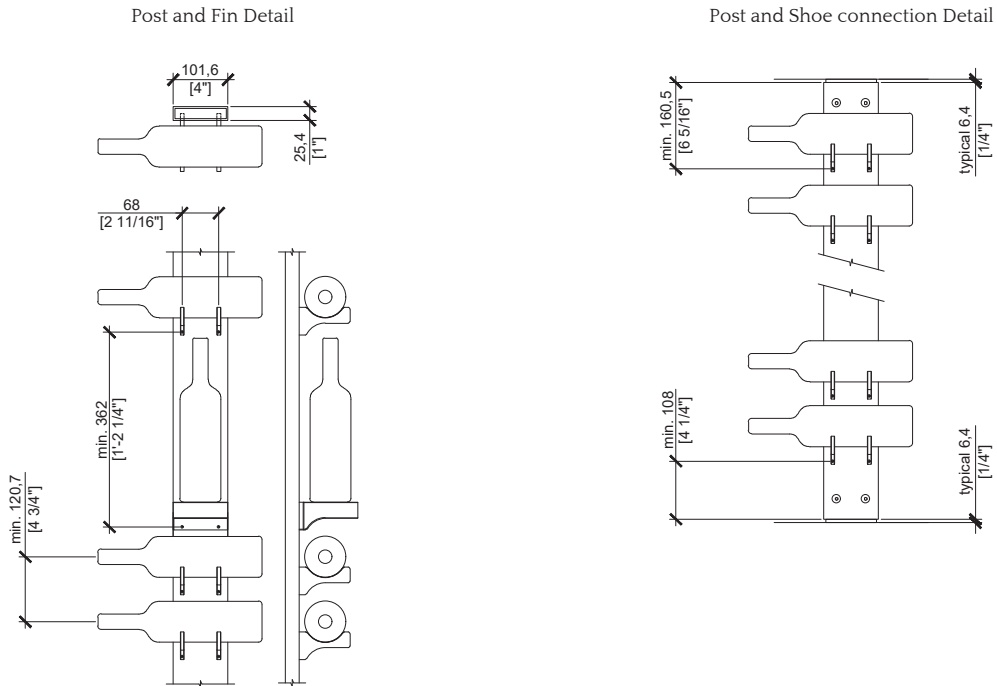

## CLASSIC and EXCLUSIVE SERIES - Row Calculation

Height of System	Number of Rows
120" (3048mm)	23
114" (2895.6mm)	22
108" (2743.2mm)	20
102" (2590.8mm)	19
96" (2438.4mm)	18
90" (2286mm)	17
84" (2133.6mm)	15
78" (1981.2mm)	14
72" (1828.8mm)	13
66" (1676.4mm)	11
60" (1524mm)	10
54" (1371.6mm)	9
48" (1219.2mm)	8
42" (1066.8mm)	6
36" (914.4mm)	5
30" (762mm)	4
24" (609.6mm)	3
18" (457.2mm)	2
12" (304.8mm)	1

### Imperial Formula (inch)

$$\frac{(\text{Height} - 9.449)}{4.75} = \text{Rows}$$

### Metric Formula (mm)

$$\frac{(\text{Height} - 240)}{120.65} = \text{Rows}$$

Example using Imperial Formula for 9'-8" ceiling height:

$$\frac{116" - 9.449}{4.75} = 22.4^*$$

\*Round down to full number, therefore 22 rows are allowable for 9'-8" ceiling height with regular spacing.